

ENGINE CONTROL SYSTEM

ACCELERATOR CONTROL SYSTEM

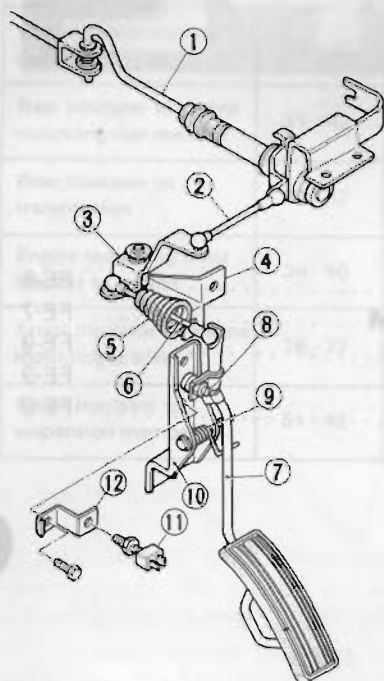

- A.S.C.D. Equipped Model
- 1 Torsion shaft
 - 2 Ball joint rod B
 - 3 Bell crank
 - 4 Bell crank bracket
 - 5 Rubber boots
 - 6 Ball joint rod A
 - 7 Accelerator pedal
 - 8 Pedal stopper
 - 9 Return spring
 - 10 Accelerator pedal bracket
 - 11 Kickdown switch (A/T only)
 - 12 Kickdown switch bracket (A/T only)
 - 13 A.S.C.D. cable

FE70B

Fig. FE-1 Accelerator control System

REMOVAL AND INSTALLATION

1. Separate ball joint rod A from pedal arm and remove pedal with bracket.

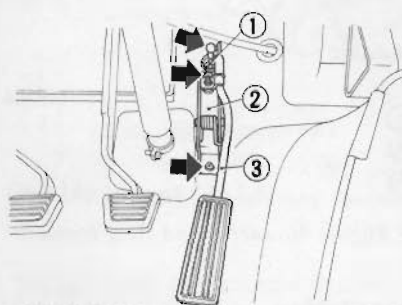

- 1 Ball joint rod A
- 2 Accelerator pedal bracket
- 3 Accelerator pedal

FE605

Fig. FE-2 Removing Accelerator Pedal

2. Disconnect A.S.C.D. cable from torsion shaft (if so equipped).
3. Separate torsion shaft from throttle shaft.

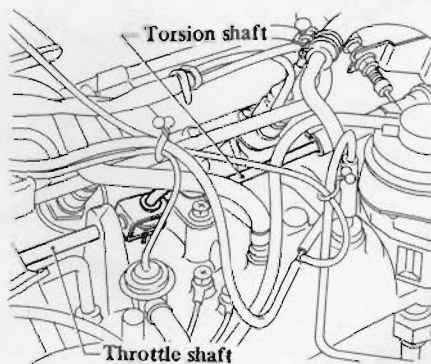

SFE359

Fig. FE-3 Separating Torsion Shaft

4. Remove ball joint rod B and remove torsion shaft.

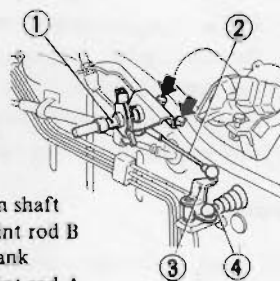

- 1 Torsion shaft
- 2 Ball joint rod B
- 3 Bell crank
- 4 Ball joint rod A

FE607

Fig. FE-4 Removing Torsion Shaft

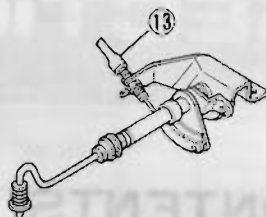

A.S.C.D. Equipped Model

5. Remove bell crank with bracket.
6. Installation is in the reverse order of removal.

Note: Apply a light coat of recommended multi-purpose grease to all sliding or friction surfaces. Do not apply grease to wire.

INSPECTION

1. Check accelerator pedal return spring for rust, fatigue or damage. Replace if necessary.
2. Check accelerator linkage for rust, damage or looseness. Repair or replace if necessary.

ADJUSTMENT

Accelerator pedal

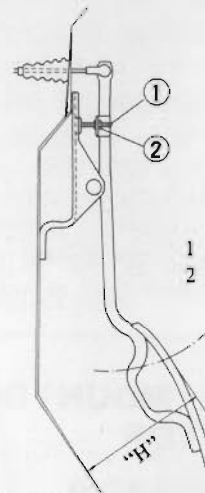

- 1 Stopper bolt
- 2 Lock nut

FE609

Fig. FE-5 Adjusting Accelerator Pedal

Adjust accelerator pedal height "H" to the specified range with pedal stopper bolt ①. Then tighten lock nut ②.

Pedal height "H":

138 to 142 mm
(5.43 to 5.59 in)

Kickdown switch

Kickdown switch adjustment is correct if it is actuated by kickdown switch plunger when accelerator pedal is fully depressed.

Always tighten lock nut securely after proper adjustment is obtained.

FUEL SYSTEM

- | | | | |
|----|-----------------------|----|-----------------|
| 1 | Fuel tank | 11 | Feed hose |
| 2 | Fuel tank gauge unit | 12 | Fuel pump |
| 3 | Filler cap | 13 | Fuel damper |
| 4 | Gas filler case cover | 14 | Return hose |
| 5 | Filler tube | 15 | Brake tube |
| 6 | Filler hose | 16 | Feed tube |
| 7 | Evapo. hose | 17 | Evapo. tube |
| 8 | Evapo. tube | 18 | Return tube |
| 9 | Check valve | 19 | Fuel filter |
| 10 | Ventilation hose | 20 | Carbon canister |

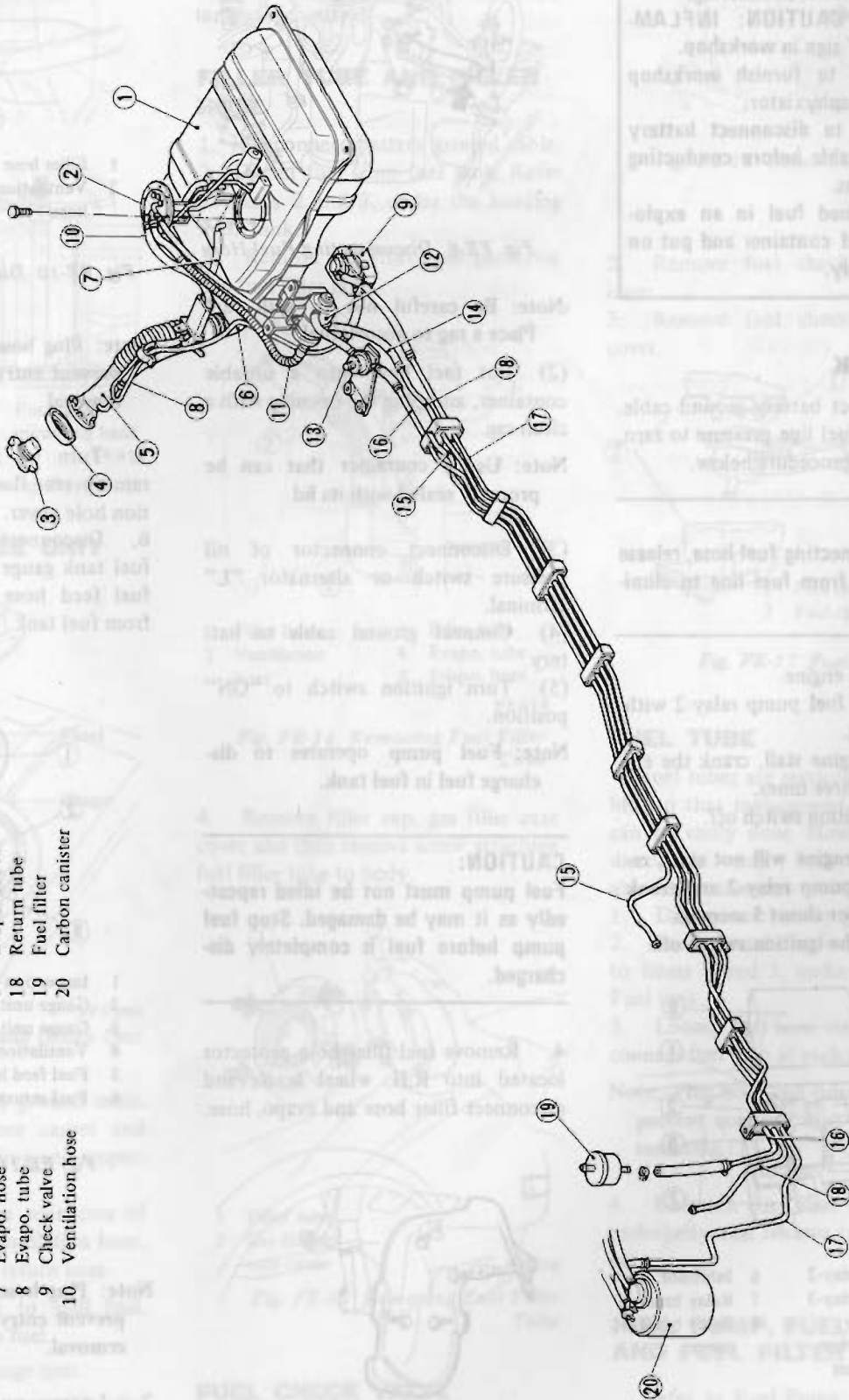

REMOVAL

WARNING: When replacing fuel line parts be sure to observe the following:

A. CAUTION: IF FLAMMABLE, use in workshop.

B. Be sure to finish workshop with an evaporator.

C. Be sure to disconnect battery ground cable before conducting operation.

D. Put drained fuel in an explosion-proof container and put on securely.

FUEL TANK

1. Disconnect battery ground cable.

2. Reduce fuel line pressure to zero following the procedure below.

CAUTION: Before disconnecting fuel hose, release fuel pressure from fuel tank by turning ignition.

CAUTION: The engine will not start if the fuel pump relay is not in the correct position.

(1) Start the engine.

(2) Turn ignition switch to "OFF".

Note: Fuel pump operates in 4th gear when the ignition switch is in "ON" position.

(3) After engine stall, crank the engine for 10-15 seconds.

(4) Turn ignition switch to "OFF".

Repeat the operation until the fuel pump relay is in the correct position.

1. Fuel pump relay

2. Fuel pump relay

3. Fuel pump relay

4. Fuel tank

5. Fuel tank

6. Fuel tank

7. Fuel tank

8. Fuel tank

9. Fuel tank

10. Fuel tank

FE611

Fig. FE-6 Fuel Tank and Fuel Line

REMOVAL

WARNING:

When replacing fuel line parts, be sure to observe the following:

- a. Put a "CAUTION: INFLAMMABLE" sign in workshop.
- b. Be sure to furnish workshop with an asphyxiator.
- c. Be sure to disconnect battery ground cable before conducting operations.
- d. Put drained fuel in an explosion-proof container and put on lid securely.

FUEL TANK

1. Disconnect battery ground cable.
2. Reduce fuel line pressure to zero, following the procedure below.

CAUTION:

Before disconnecting fuel hose, release fuel pressure from fuel line to eliminate danger.

- (1) Start the engine.
- (2) Remove fuel pump relay-2 with engine running.
- (3) After engine stall, crank the engine twice or three times.
- (4) Turn ignition switch off.

Note: If the engine will not start, remove fuel pump relay-2 and crank the engine for about 5 seconds. Then turn the ignition switch off.

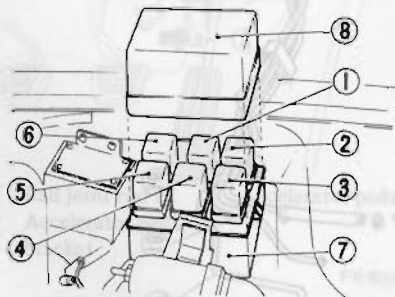

- | | |
|-------------------------|-----------------------|
| 1 Fuel pump relay-2 | 6 Inhibitor relay |
| 2 Fuel pump relay-3 | 7 Relay bracket |
| 3 Lighting relay | 8 Relay bracket cover |
| 4 Bulb check relay | |
| 5 Air conditioner relay | |

SEF763

Fig. FE-7 Relays

3. Drain the fuel from tank, following the procedure below.

- (1) Disconnect fuel hose from fuel tube.

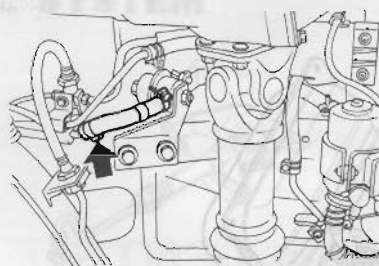

FE612

Fig. FE-8 Disconnecting Fuel Hose

Note: Be careful not to spill fuel. Place a rag to absorb fuel.

- (2) Put fuel hose into a suitable container, and plug the opening with a clean rag.

Note: Use a container that can be properly sealed with its lid.

- (3) Disconnect connector of oil pressure switch or alternator "L" terminal.
- (4) Connect ground cable to battery.
- (5) Turn ignition switch to "ON" position.

Note: Fuel pump operates to discharge fuel in fuel tank.

CAUTION:

Fuel pump must not be idled repeatedly as it may be damaged. Stop fuel pump before fuel is completely discharged.

4. Remove fuel filler hose protector located into R.H. wheel house and disconnect filler hose and evapo. hose.

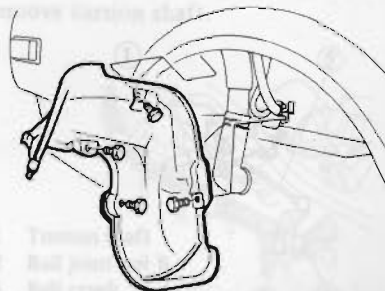

FE613

Fig. FE-9 Removing Fuel Filler Hose Protector

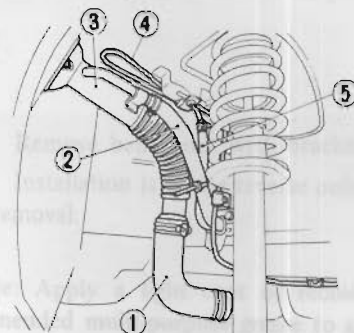

- | | |
|--------------------|---------------|
| 1 Filler hose | 3 Filler tube |
| 2 Ventilation hose | 4 Evapo. tube |
| | 5 Evapo. hose |

FE614

Fig. FE-10 Disconnecting Fuel Filler Hose

Note: Plug hose and pipe openings to prevent entry of dust or dirt during removal

5. Turn up rear floor carpet and remove rear floor padding and inspection hole cover.
6. Disconnect harness connector of fuel tank gauge unit, ventilation hose, fuel feed hose and fuel return hose from fuel tank.

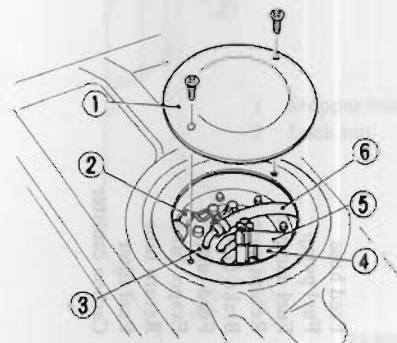

- | |
|--------------------------------|
| 1 Inspection hole cover |
| 2 Gauge unit harness connector |
| 3 Gauge unit |
| 4 Ventilation hose |
| 5 Fuel feed hose |
| 6 Fuel return hose |

FE615

Fig. FE-11 Disconnecting Hoses

Note: Plug hose and pipe openings to prevent entry of dust or dirt during removal.

7. Loosen nuts and take off fuel tank mounting bands. Then remove fuel tank.

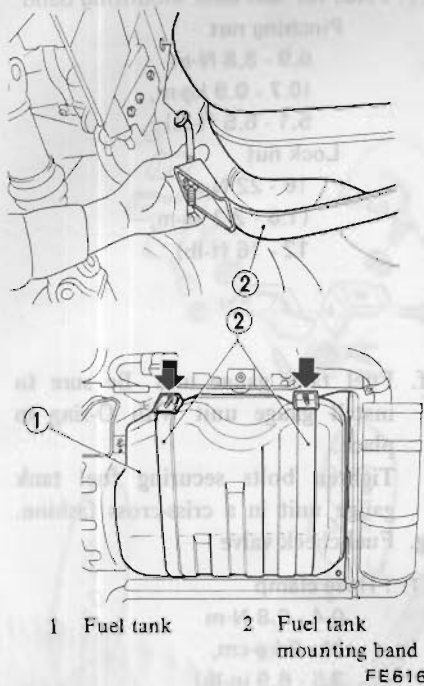

Fig. FE-12 Removing Fuel Tank

FUEL TANK GAUGE UNIT

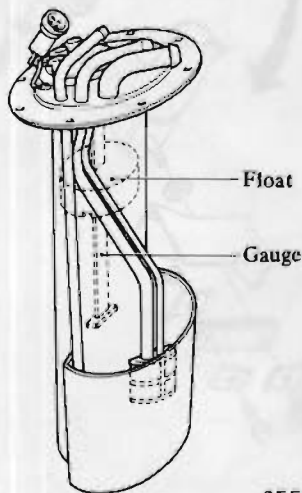

Fig. FE-13 Fuel Tank Gauge Unit

1. Disconnect battery ground cable.
2. Turn up rear floor carpet and remove rear floor padding and inspection hole cover.
3. Disconnect harness connector of fuel tank gauge unit, ventilation hose, fuel feed hose and fuel return hose.

Note: Be careful not to spill fuel. Place a rag to absorb fuel.

4. Remove fuel tank gauge unit.

Note: After removing gauge unit, plug the opening to prevent entry of dust or dirt.

FUEL TANK FILLER

1. Remove fuel tank gauge unit. Refer to Fuel Tank Gauge Unit for removal.
2. Remove fuel tank filter from fuel tank gauge unit.

FILLER TUBE AND FILLER HOSE

1. Disconnect battery ground cable.
2. Drain fuel from fuel tank. Refer to items 2 and 3, under the heading Fuel Tank.
3. Remove fuel filler hose protector and fuel filler hose.

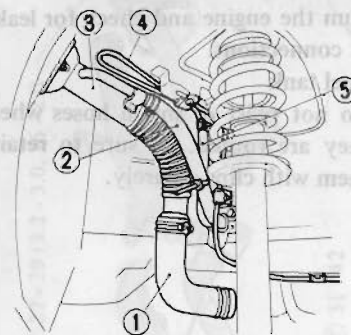

- | | |
|--------------------|---------------|
| 1 Filler hose | 3 Filler tube |
| 2 Ventilation hose | 4 Evapo. tube |
| | 5 Evapo. hose |

FE614

Fig. FE-14 Removing Fuel Filler Tube

4. Remove filler cap, gas filler case cover and then remove screw attaching fuel filler tube to body.

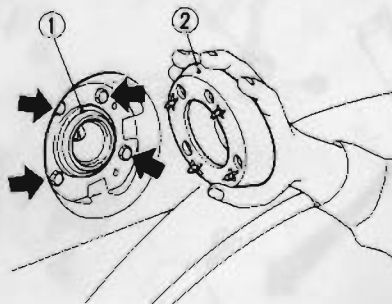

- | |
|-------------------------|
| 1 Filler tube |
| 2 Gas filler case cover |

FE618

Fig. FE-15 Removing Fuel Filler Tube

FUEL CHECK VALVE

1. Disconnect hoses connecting fuel check valve to evapo. tubes.

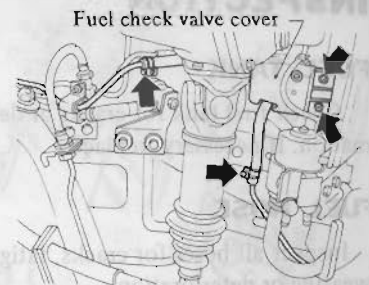

FE619

Fig. FE-16 Removing Fuel Check Valve

2. Remove fuel check valve with cover.
3. Remove fuel check valve from cover.

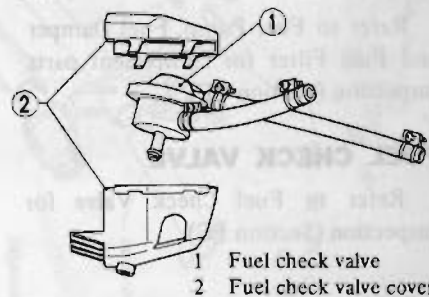

Fig. FE-17 Fuel Check Valve

FUEL TUBE

Fuel tubes are serviced as an assembly, so that replacement of fuel tube can be easily done. However, do not disconnect any fuel line unless absolutely necessary.

1. Disconnect battery ground cable.
2. Drain fuel from fuel tank. Refer to items 2 and 3, under the heading Fuel tank.
3. Loosen fuel hose clamps and disconnect fuel tube at each end.

Note: Plug hose and tube openings to prevent entry of dust or dirt while removing.

4. Unfasten clips that hold tube on underbody and remove tube from the car.

FUEL PUMP, FUEL DAMPER AND FUEL FILTER

Refer to Fuel Pump, Fuel Damper and Fuel Filter for removal and installation (Section EF).

INSPECTION

FUEL TANK

Check fuel tank for cracks or deformation. If necessary, replace.

FUEL HOSE

Inspect all hoses for cracks, fatigue, sweating or deterioration.

Replace any hose that is damaged.

FUEL TUBE

Replace any fuel tube that is cracked, rusted, collapsed or deformed.

FUEL PUMP, FUEL DAMPER AND FUEL FILTER

Refer to Fuel Pump, Fuel Damper and Fuel Filter for component parts inspection (Section EF).

FUEL CHECK VALVE

Refer to Fuel Check Valve for inspection (Section EC).

INSTALLATION

Install any parts of the fuel system in the reverse order of removal. Observe the following notes and refer to Fuel Filter, Fuel Pump, Fuel Damper and Fuel Hose for removal and installation (Section EF).

Note:

- a. Install hose clamps securely. Do not overtighten to avoid damaging hoses.
- b. Fasten clips holding fuel tube on underbody securely.
- c. Do not kink or twist hose and tube when they are routed.
- d. Run the engine and check for leaks at connections.
- e. Fuel tank
Do not twist or smash hoses when they are routed. Be sure to retain them with clips securely.

Ⓣ : Nut for fuel tank mounting band

Pinching nut

6.9 - 8.8 N·m

(0.7 - 0.9 kg-m,

5.1 - 6.5 ft-lb)

Lock nut

16 - 22 N·m

(1.6 - 2.2 kg-m,

12 - 16 ft-lb)

- f. Fuel tank gauge unit. Be sure to install gauge unit with O-ring in place.

Tighten bolts securing fuel tank gauge unit in a criss-cross fashion.

- g. Fuel check valve

Ⓣ : Hose clamp

0.4 - 0.8 N·m

(4 - 8 kg-cm,

3.5 - 6.9 in-lb)



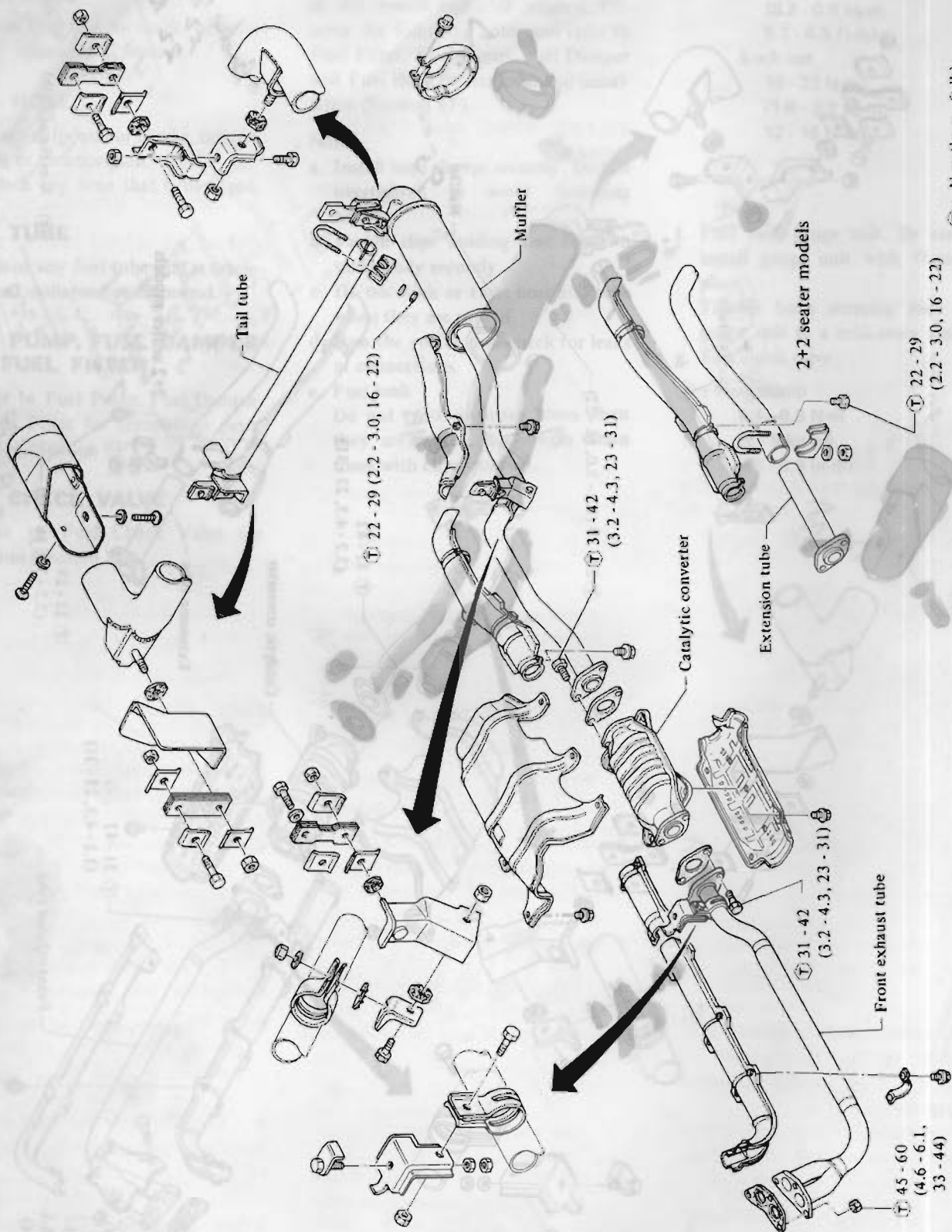

Fig. FE-19 Exhaust System (Canada models)

REMOVAL

WARNING:

You should not remove the exhaust system until it has been cooled off. Otherwise, you may burn yourself.

FRONT EXHAUST TUBE

1. Remove catalytic converter lower shelter.
2. Remove bolts or nuts attaching front exhaust tube to exhaust manifold, transmission rear extension and catalytic converter or premuffler. Front exhaust tube can then be taken out.

CATALYTIC CONVERTER

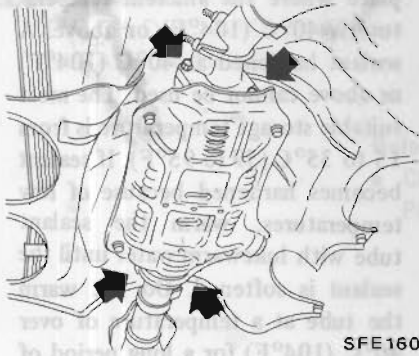

SFE160

Fig. FE-20 Catalytic Converter

Remove catalytic converter lower shelter and remove catalytic converter.

CAUTION:

- a. Be careful not to damage catalytic converter when handling.
- b. Never wet catalytic converter with water, oil, etc.

EXTENSION TUBE (2+2 seater models)

1. Remove catalytic converter.
2. Remove center exhaust tube upper heat insulator.
3. Remove U-bolt and U-bolt clamp.
4. Break sealant off connection by lightly tapping around tube with a hammer and twisting extension tube. Extension tube can then be taken out.

MUFFLER

1. Remove following parts.
 - Tail tube
 - Tunnel second crossmember.
 - Catalytic converter and heat insulator
 - Center exhaust tube upper and heat insulator and extension tube. (2+2 seater models)
2. Remove nut attaching exhaust tube to mounting bracket. Muffler can then be taken out.

TAIL TUBE

1. Remove nut attaching tail tube to mounting bracket.
2. Remove U-bolt and U-bolt clamp.
3. Break sealant off connection by lightly tapping around tube with a hammer and twisting tail tube. Tail tube can then be taken out.

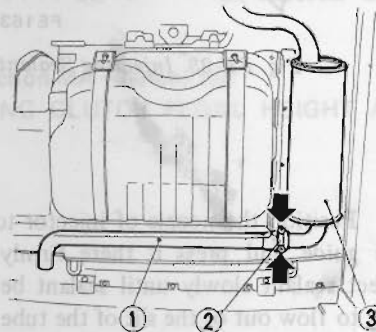

- 1 Tail tube
- 2 U-bolt
- 3 Muffler

FE624

Fig. FE-21 Tail Tube

INSPECTION

1. Check, muffler and tubes for cracks, damage or corrosion. Replace if necessary.
2. Check catalytic converter, referring to Section EC. Replace if necessary.
3. Replace bracket and mounting rubber that are cracked, fatigued or sweated.

INSTALLATION

Install exhaust system which has been removed as an assembly in reverse order of removal.

INSTALLATION PRECAUTIONS

1. When assembling, be careful not to let gas leak from around connections of exhaust system components. Evenly tighten nut securing exhaust manifold to front exhaust tube.
2. When installing exhaust tube and muffler, make sure that a proper clearance is maintained between these parts and parts on car body.
3. Be sure to install new gaskets and bolts after removing following parts.
 - Front tube
 - Catalytic converter

Note:

- a. After installation, check that mounting brackets, mounting rubbers and mounting insulator are free from undue stress.

If any of above parts is not installed properly, excessive noises or vibrations may be transmitted to car body.

- b. Check all tube connections for exhaust gas leaks, and entire system for unusual noises, with engine running.

SEALING COMPOUND

If exhaust tubes are separated at connection to renew muffler assembly, etc., use the Genuine Nissan Sealant "Exhaust Sealant Kit 20720-N2225" to eliminate gas leakage past the joint. Be sure to observe following procedures.

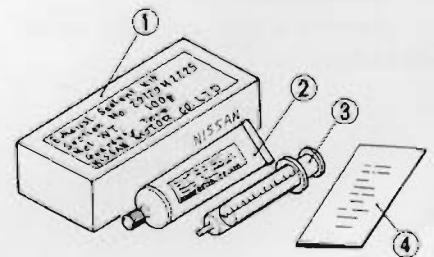

- 1 Case
- 2 Sealant tube (polyethylene)
- 3 Injector
- 4 Instruction sheet

FE109

Fig. FE-22 Exhaust Sealant Kit

1. Wipe clean all the contact portions of tube joints; allow them to dry thoroughly.
2. Temporarily mount in place muffler assembly (and/or exhaust tube) as an assembled unit on the car.
3. Insert the male tube into the female tube fully until the front end of the female tube touches the stopper on the male tube.
4. Torque U-bolt securing nuts to specifications.

Ⓣ : U-bolt securing nuts
 22 - 29 N·m
 (2.2 - 3.0 kg·m,
 16 - 22 ft·lb)

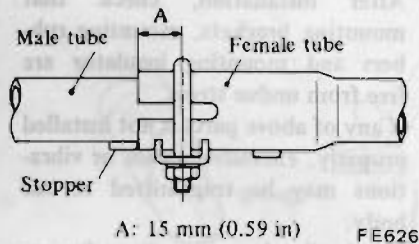

Fig. FE-23 Exhaust Tube Connection

5. Squeeze 5 to 6 cm³ (0.31 to 0.37 cu in) of sealant into injector from the sealant tube.

Be sure to place the cap back to the sealant tube since sealant will dry.

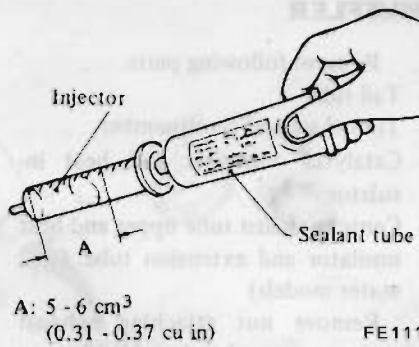

Fig. FE-24 Squeezing Sealant to Injector

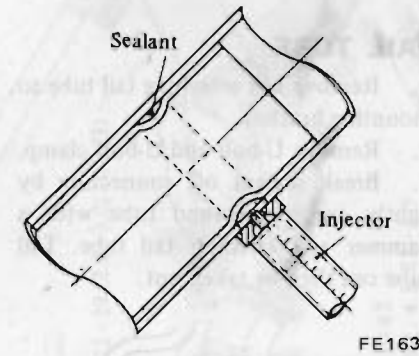

Fig. FE-25 Injecting Sealant

6. Position the nozzle of injector to the guide and press it there firmly. Inject sealant slowly until sealant begins to flow out of the slit of the tube. This indicates that the bead requires no further sealant. Excessive sealant can cause a clogged tube.

After injecting, wash injector thoroughly in clean water to remove all traces of sealant.

7. Start the engine and let it idle slowly for ten minutes (minimum) to harden sealant with the heat of exhaust gas.
8. Check the condition of sealant before driving the car. It is also essential that the car should not be accelerated sharply for 20 to 30 minutes subsequent to this operation.

Note:

- a. The sealant should be used within guaranty term indicated on the kit case.
- b. Exposure of sealant to the skin may cause a rash. Wash sealant off the skin with water.
- c. Do not keep the sealant tube in a place where the ambient temperature is 40°C (104°F) or above. A sealant hardened at 40°C (104°F) or above cannot be used. The most suitable storage temperature is from 15 to 35°C (59 to 95°F). If sealant becomes hardened because of low temperatures, warm the sealant tube with lukewarm water until the sealant is softened. Do not warm the tube at a temperature of over 40°C (104°F) for a long period of time.
- d. Thoroughly read the instruction sheet furnished with the kit before using the sealant.

CAUTION: Do not use sealant on damaged or corroded surfaces. Wash sealant off skin with water, oil, etc.

EXTENSION TUBE (3 + 2 sealer models): 1. Remove U-bolt and U-bolt clamp. 2. Break sealant off connection by lightly tapping around tube with hammer and twisting extension tube. 3. Remove U-bolt and U-bolt clamp. 4. Remove U-bolt and U-bolt clamp.

INSTALLATION: Install exhaust system which has been removed as an assembly in reverse order of removal.